

N20011 | STEEL

N20012 | ALU

EVOS RAIL KIT

A + R

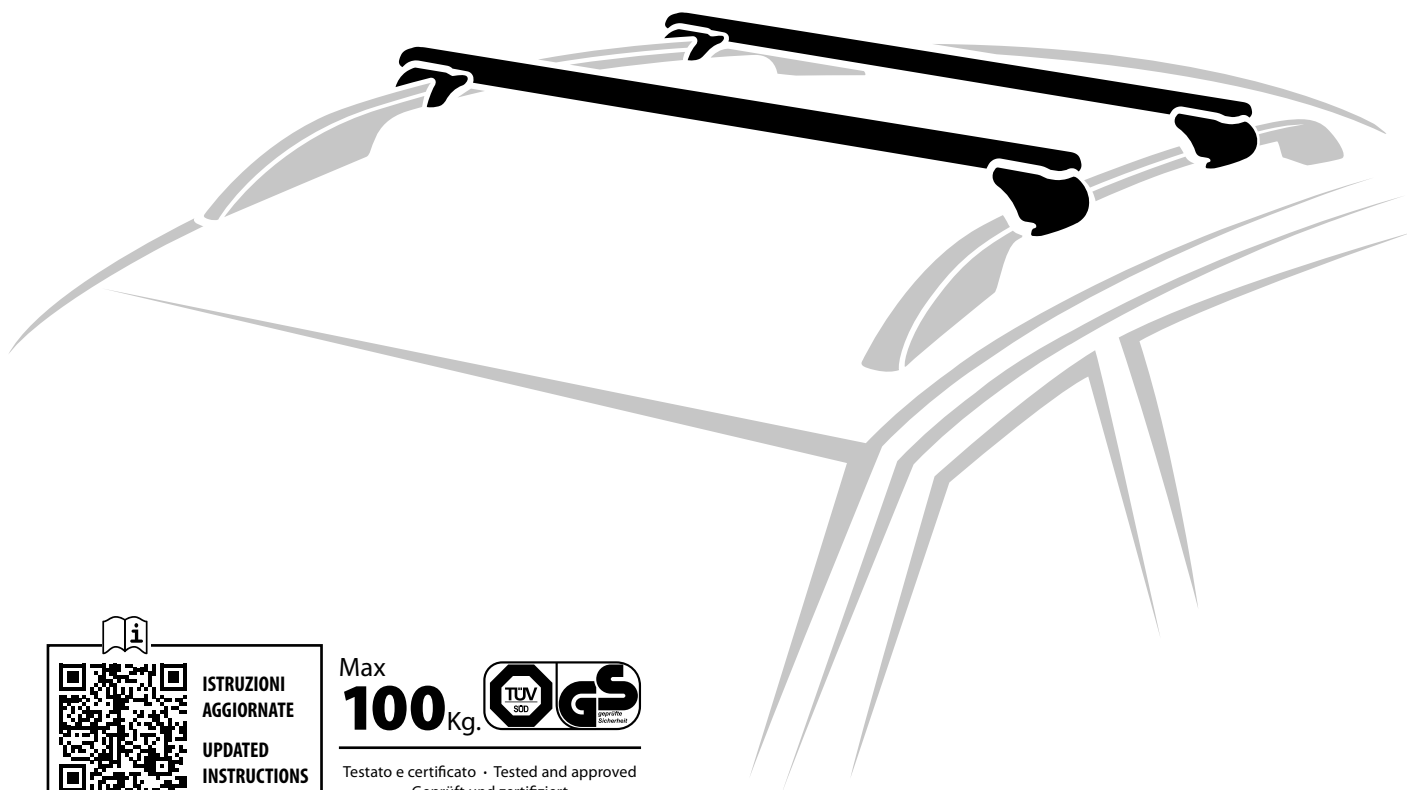

Max **100** Kg. 
Testato e certificato · Tested and approved
Geprüft und zertifiziert

91CA0064 r07

- | | | | |
|-----------------------------------|--------------------------------------|-------------------------------------|---------------------------------|
| I Istruzioni di montaggio | NL Montage-instructies | PL Instrukcja montażu | H A felszerelés módja |
| EN Fitting instructions | S Monteringsanvisning | RUS Инструкции по установке | GR Οδηγία συναρμολόγησης |
| F Instructions de montage | FIN Asennusohje | CZ Návod na montáž | TR Montaj talimatları |
| D Montageanleitung | EST Paigaldusjuhend | SK Návod na montáž | BG Инструкции за монтаж |
| E Instrucciones de montaje | LAT Stiprināšanas instrukcija | SLO Navodila za pritrjevanje | SRB Uputstva za montažu |
| P Instruções de montagem | LT Pritvirtinimo instrukcijos | HR Uputa za sastavljanje | |



Safety Regulations

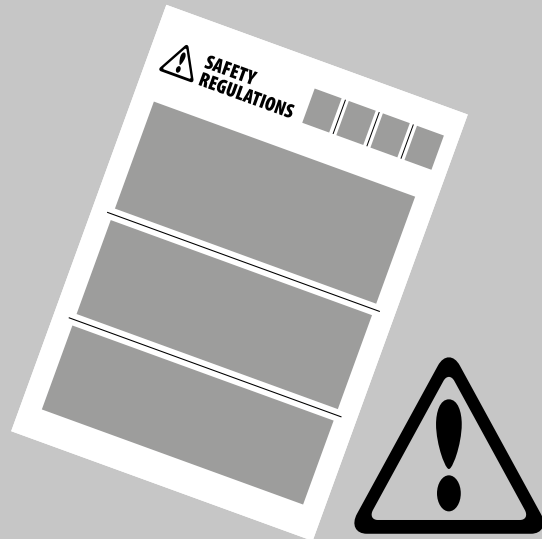
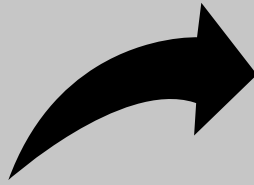

- I** Leggere il libretto di sicurezza e garanzia incluso nel prodotto prima dell'uso. Per maggiori informazioni visita il sito **www.nordrive.it** o contattare direttamente il rivenditore locale.
- EN** Before using this product, please read the enclosed safety and warranty booklet. For more information please visit **www.nordrive.it** or contact your local dealer.
- F** Avant d'utiliser ce produit, veuillez lire le livret de sécurité et de garantie inclus. Pour plus d'informations, visitez le site **www.nordrive.it** ou contactez votre revendeur local.
- D** Bevor die Verwendung des Produkts, die Sicherheitsbrochure und Garantieheft lesen. Für weitere Informationen empfehlen wir Ihnen die Webseite **www.nordrive.it** zu besuchen oder direkt den örtlichen Wiederkäufer zu kontaktieren.
- E** Antes de usar este producto, lea el folleto de seguridad y garantía incluido. Para obtener más información, visite **www.nordrive.it** o póngase en contacto con su distribuidor local.
- P** Antes de usar este produto, por favor leia o livro de segurança e garantia incluso. Para obter mais informações, visite **www.nordrive.it** ou entre em contato com seu revendedor local.
- NL** Lees voor het gebruik van dit product het bijgevoegde veiligheids- en garantieboekje. Ga voor meer informatie naar **www.nordrive.it** neem contact op met uw lokale dealer.
- S** Före användning av denna produkt, vänligen läs den medföljande broschyren om säkerhet och garantivillkor. För mer information vänligen besök **www.nordrive.it** eller kontakta er lokala återförsäljare.
- FIN** Ennen kuin käytät tätä tuotetta, lue mukana toimitettu turva- ja takuukirja. Lisätietoja on osoitteessa **www.nordrive.it** tai ota yhteys paikalliseen jälleenmyyjään.
- EST** Enne toote kasutamist tutvuge kaasasoleva ohutus- ja garantiijuhendiga. Lisateabe saamiseks külastage veebisaiti **www.nordrive.it** või pöörduge kohaliku edasimüüja poole.
- LAT** Pirms šī produkta izmantošanas, lūdzu, izlasiet pievienoto drošības un garantijas bukletu. Lai iegūtu vairāk informācijas, lūdzu, apmeklējiet vietni **www.nordrive.it** vai sazinieties ar vietējo izplatītāju.
- LT** Prieš pradėdant naudoti šį produktą, prašome perskaityti pridėtus saugos ir garantinius lapus. Daugiau informacijos rasite apsilankę **www.nordrive.it** arba tiesiogiai susisiekdami su mūsų vietiniu atstovu.
- PL** Przed użyciem tego produktu prosimy o zapoznanie się z załączoną książeczką bezpieczeństwa i gwarancji. Aby uzyskać więcej informacji, odwiedź **www.nordrive.it** lub skontaktuj się z lokalnym sprzedawcą.
- RUS** Перед использованием продукта ознакомьтесь с буклетом по технике безопасности и гарантией. Для получения дополнительной информации рекомендуем посетить сайт **www.nordrive.it** или обратиться непосредственно к местному дилеру.
- CZ** Před použitím produktu si přečtěte přiloženou bezpečnostní a záruční brožuru. Další informace najdete na **www.nordrive.it** nebo přímo u místního prodejce.
- SK** Pred použitím produktu, prosím naštudujte najprv priložený manuál a bezpečnostné pokyny. Pre viac informácií prosím navštívte **www.nordrive.it** alebo kontaktujte miestneho predajcu/ zástupcu.
- SLO** Pred uporabo proizvoda preberi priložena navodila in garancijsko izjavo. Za več informacij obiščite internetno stran **www.nordrive.it** ali kontaktirajte lokalnega prodajalca.
- HR** Prije uporabe ovog proizvoda, pročitajte priloženo uputstvo o sigurnosti i jamstvu. Za više informacija posjetite **www.nordrive.it** ili kontaktirajte svog lokalnog distributera.
- H** Használat előtt kérjük figyelmesen olvassa el a biztonsági és garanciális útmutatót. Több információért kérjük keresse fel a **www.nordrive.it** weboldalt vagy lépjen kapcsolatba a honi forgalmazóval.
- GR** Πριν χρησιμοποιήσετε το προϊόν, παρακαλούμε διαβάστε το φυλλάδιο ασφάλειας και εγγύησης. Για περισσότερες πληροφορίες, επισκεφθείτε το **www.nordrive.it** ή επικοινωνήστε με τον τοπικό σας αντιπρόσωπο.
- TR** Bu ürünü kullanmadan önce lütfen ekteki güvenli ve garanti kitapçığını okuyun. Daha fazla bilgi için lütfen **www.nordrive.it** adresini ziyaret edin veya yerel bayinizle iletişime geçin.
- BG** Моля преди да използвате този продукт, прочетете инструкциите за безопасност и книжката с гаранционните условия. За повече информация моля посетете **www.nordrive.it** или се свържете с местния дистрибутор.
- SRB** Pre upotrebu ovog proizvoda, pažljivo pročitajte priloženu knjžicu o bezbednosti i garanciji. Za više informacija, molimo vas posetite **www.nordrive.it** ili kontaktirajte lokalnog distributera.



FEET

**N20011 - Rail Kit Steel
N20012 - Rail Kit Alu**

FEET

Contenuto • Content • Contenu • Inhalt • Contenido

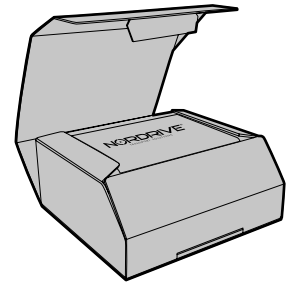

x4

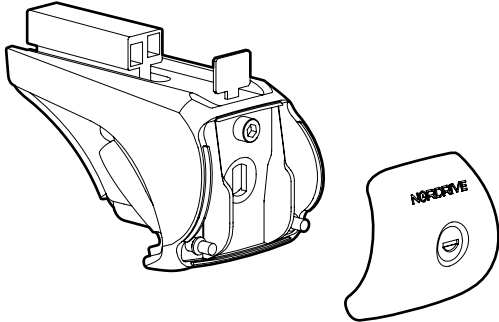

x4

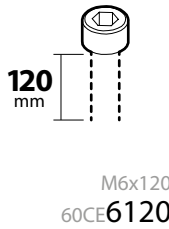

x4

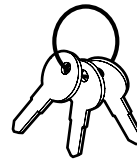

x1

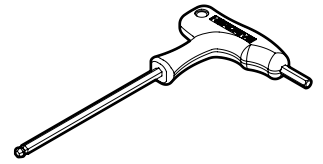

72NA0002

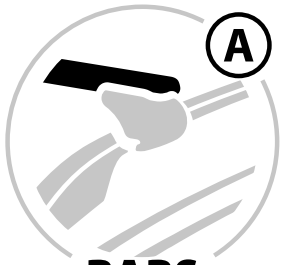

BARS

**Imballo a parte
Separate pack**

BARS

Contenuto • Content • Contenu • Inhalt • Contenido

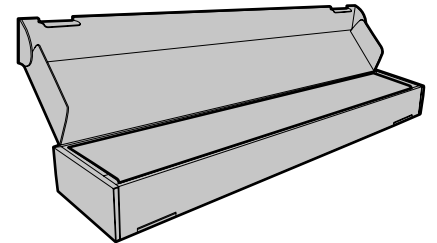

NORDRIVE QUADRA
Acciaio / Steel



NORDRIVE ALUMIA
Alluminio / Aluminium

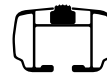

NORDRIVE HELIO
Alluminio / Aluminium



NORDRIVE SILENZIO
Alluminio / Aluminium

x2

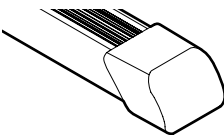

x2

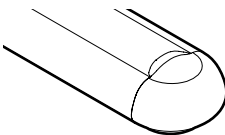

x2

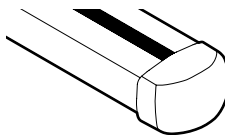

x2

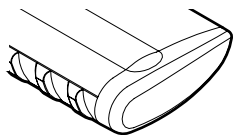

x4

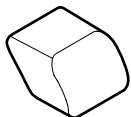

75PL097A

x4



75PL105A

x4



75PL0024

2 + 2

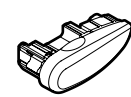

75GR0004
75GR0005

x1

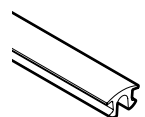

21GO164A

x1

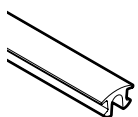

21GO164A

x1

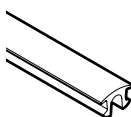

21GO164A

x2



- S** 21Go0014
- M** 21Go0001
- L** 21Go0040
- XL** 21Go0003

x2



- S** 21Go0025
- M** 21Go0026
- L** 21Go0027
- XL** 21Go0028

x2



- S** 21Go0015
- M** 21Go0016
- L** 21Go0017
- XL** 21Go0018

x4



- S** 21Go0036
- M** 21Go0037
- L** 21Go0038
- XL** 21Go0039

x2



- S** 21Go0014
- M** 21Go0001
- L** 21Go0040
- XL** 21Go0003



Attenzione • Warning • Attention • Hinweise • Advertencia

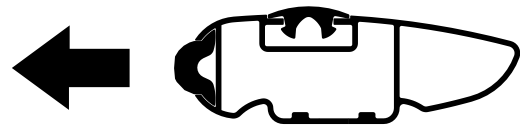
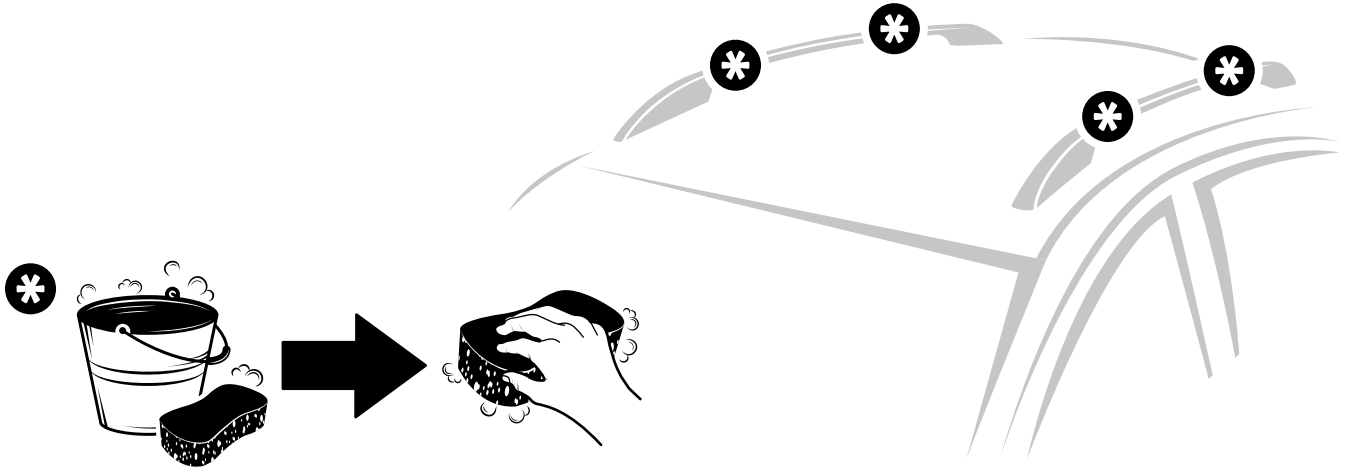

Fronte • Front • Vorderseite

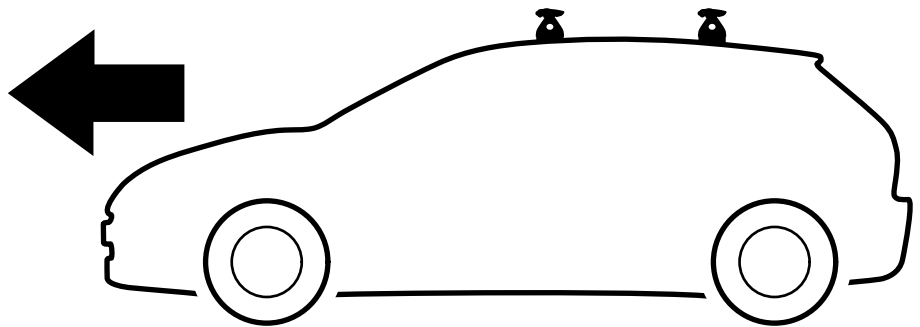

Solo per barre:
Only for bars:
Nur für stangen:

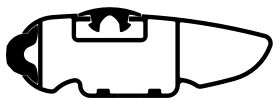

SILENZIO

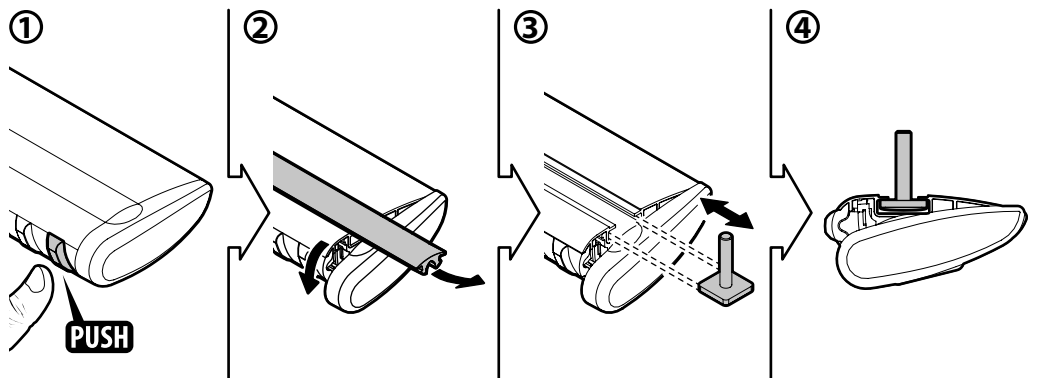



Montaggio • Fitting instructions • Montage • Montageanleitung • Montaje

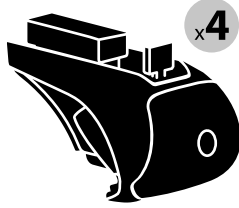

+



=

- S** 2,9 Kg
- M** 3,1 Kg
- L** 3,1 Kg
- XL** 3,3 Kg



+



+



=

Max
90 Kg.

+



=

- S** 4,9 Kg
- M** 5,1 Kg
- L** 5,3 Kg
- XL** 5,7 Kg

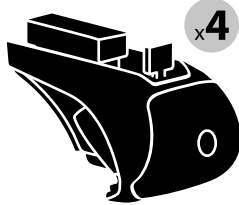

+



=

- S** 3,5 Kg
- M** 3,7 Kg
- L** 3,9 Kg
- XL** 4,1 Kg

+



=

- S** 3,7 Kg
- M** 3,9 Kg
- L** 4,1 Kg
- XL** 4,3 Kg



+



+



=

Max
100 Kg.



max kg. ??

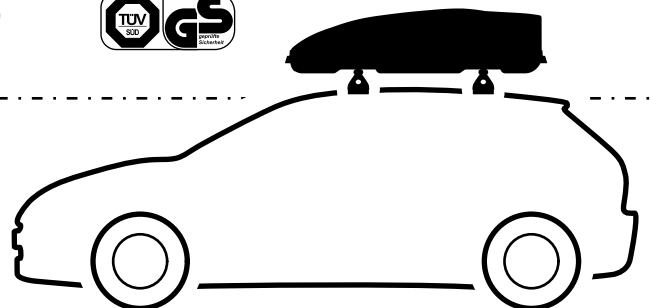

1



NORDRIVE QUADRA
Acciaio / Steel

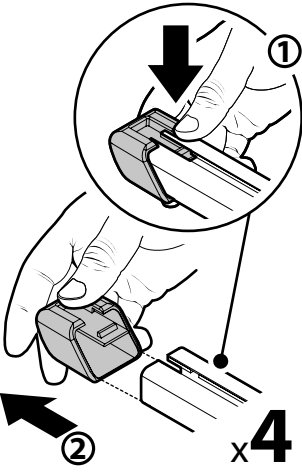



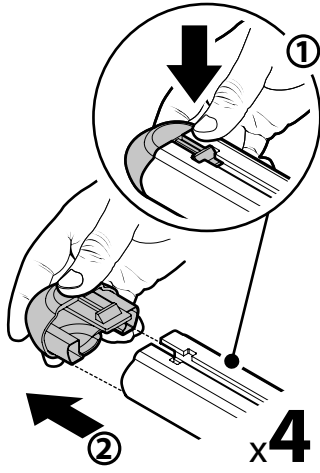

NORDRIVE ALUMIA
Alluminio / Aluminium

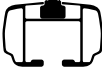

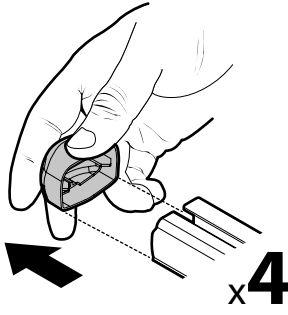

NORDRIVE HELIO
Alluminio / Aluminium





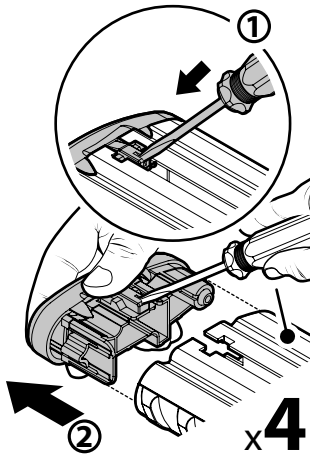

NORDRIVE SILENZIO
Alluminio / Aluminium

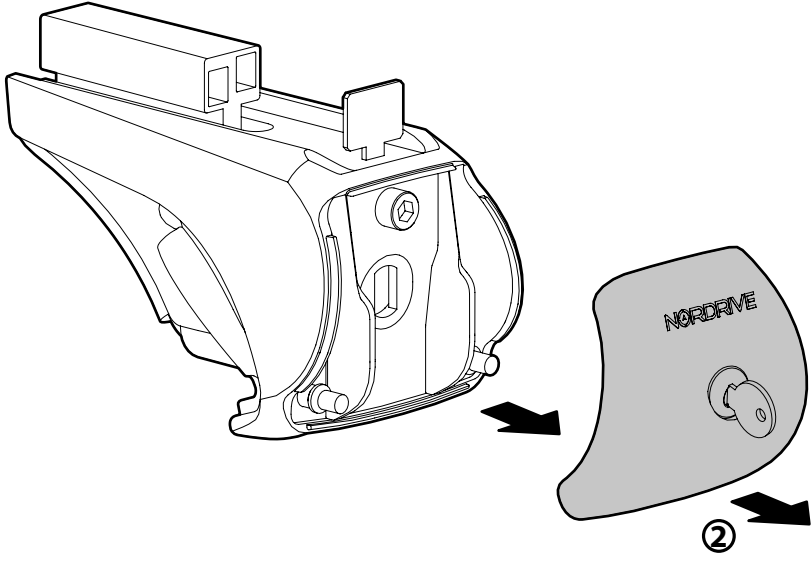

2



①



Locked



Opened

②

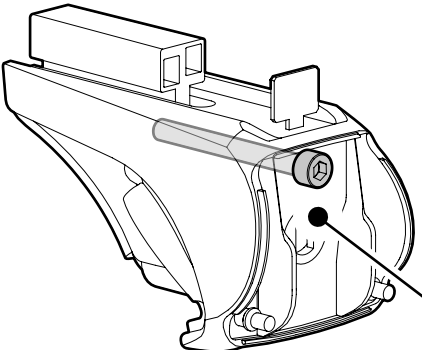

x4

3

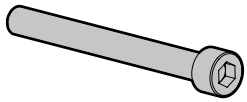



Vite / Screw / Schraube

		Railing		
				
Preassemblate Pre-assembled Vormontiert	>100 mm <small>M6x100 60CE6900</small>	✓	✓	
Include Included Inbegriffen	>120 mm <small>M6x120 60CE6120</small>		✓	✓

x4

4

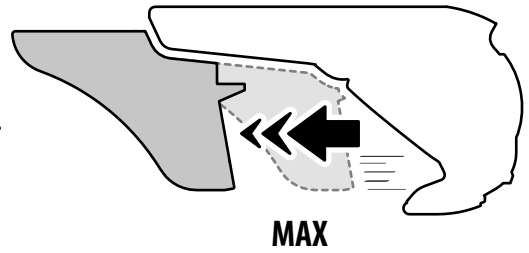
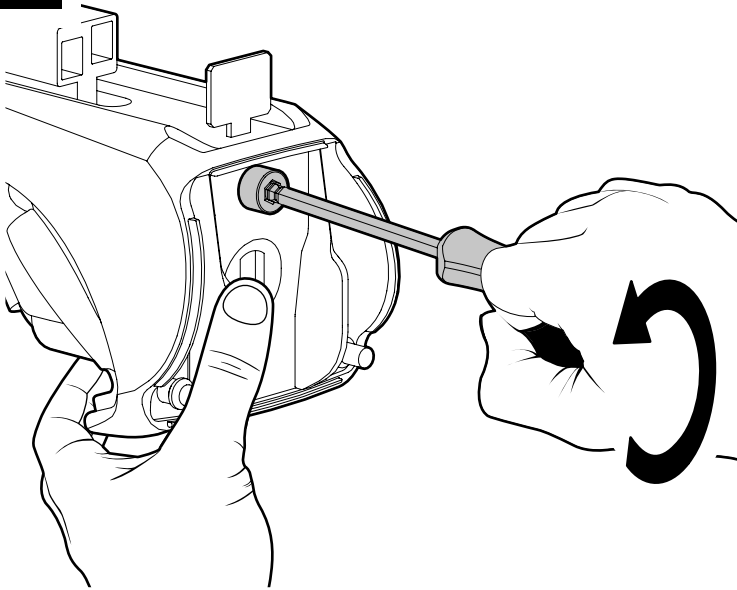

x4

5

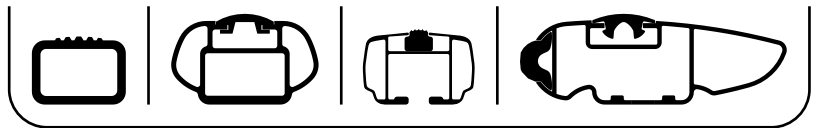
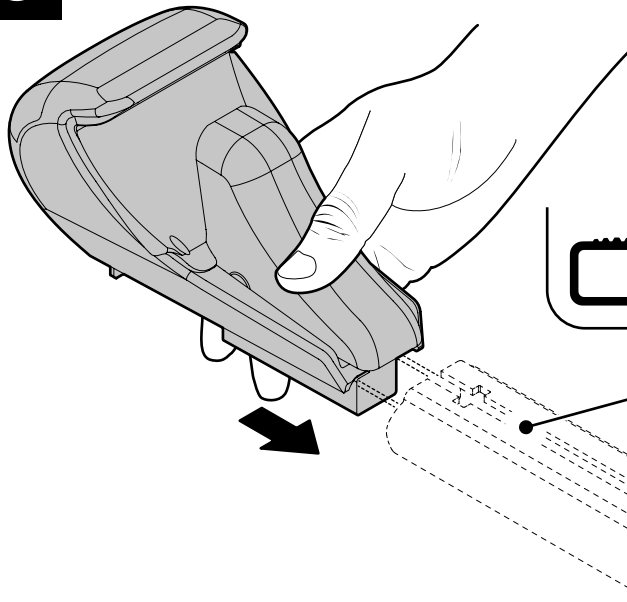

x4

6



NORDRIVE **QUADRA**
Acciaio / Steel

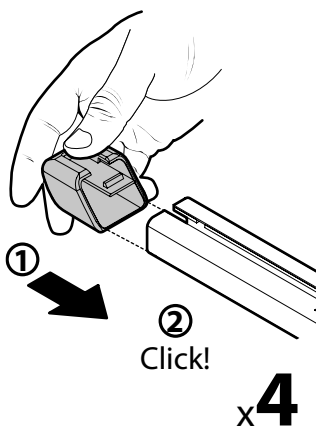

NORDRIVE **ALUMIA**
Alluminio / Aluminium

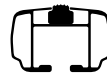
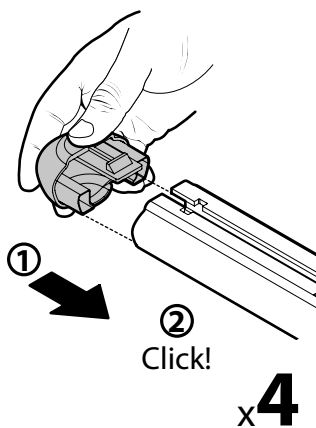

NORDRIVE **HELIO**
Alluminio / Aluminium

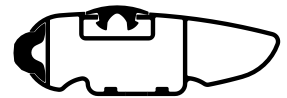
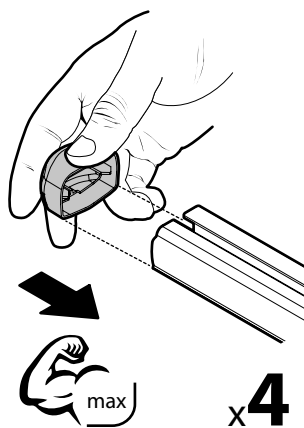

NORDRIVE **SILENZIO**
Alluminio / Aluminium

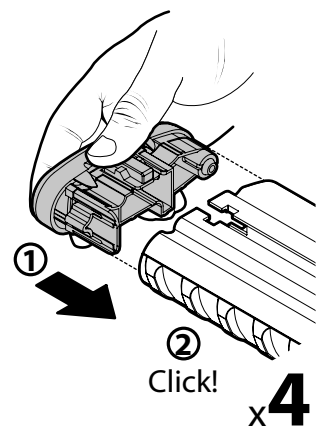

7



8

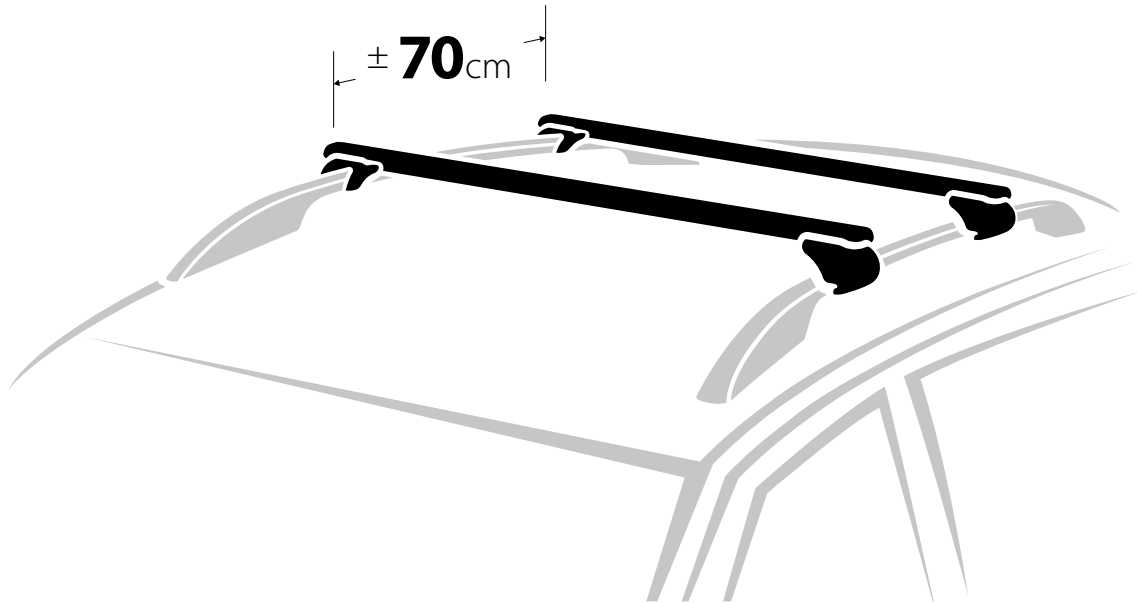

9

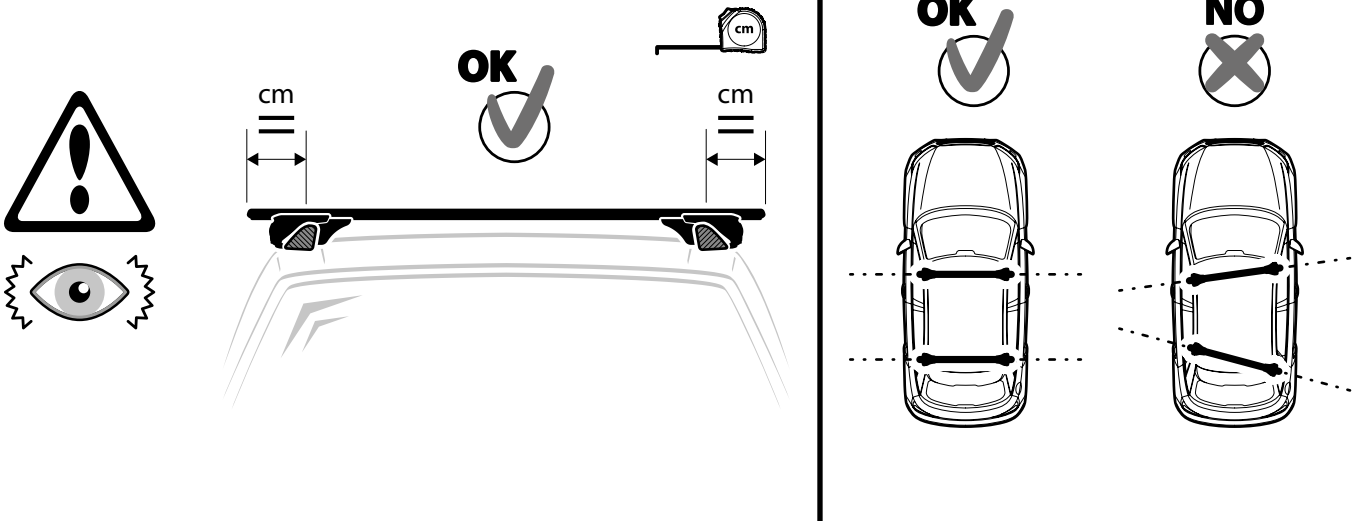

10

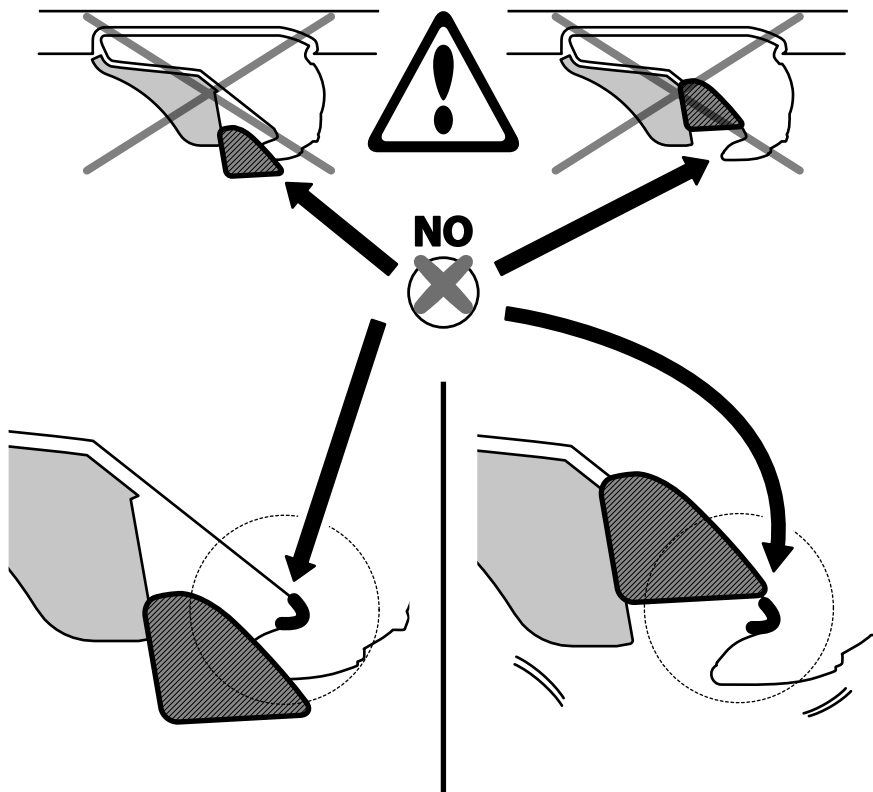
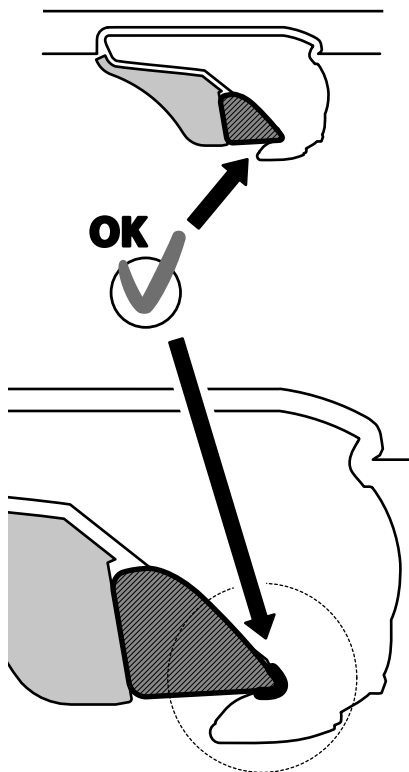
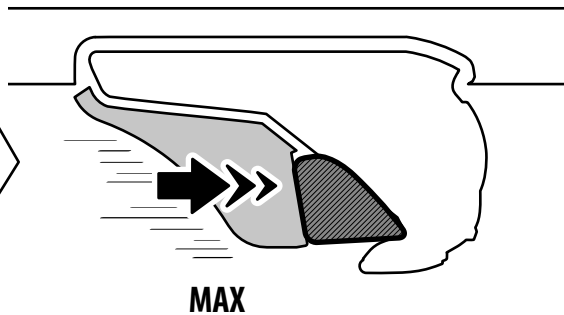
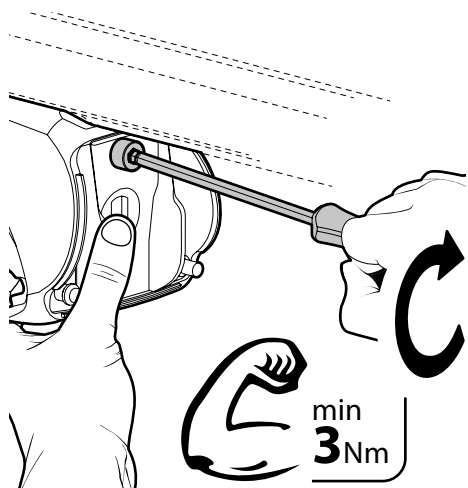
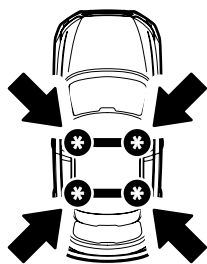

11

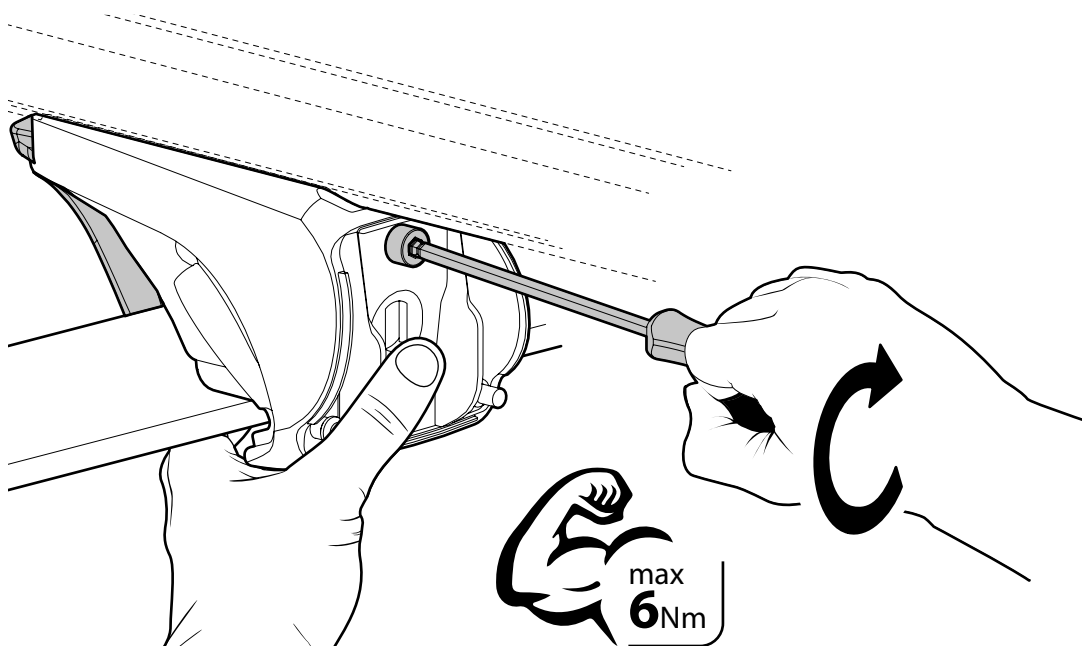
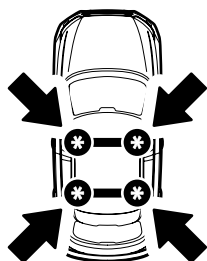

12

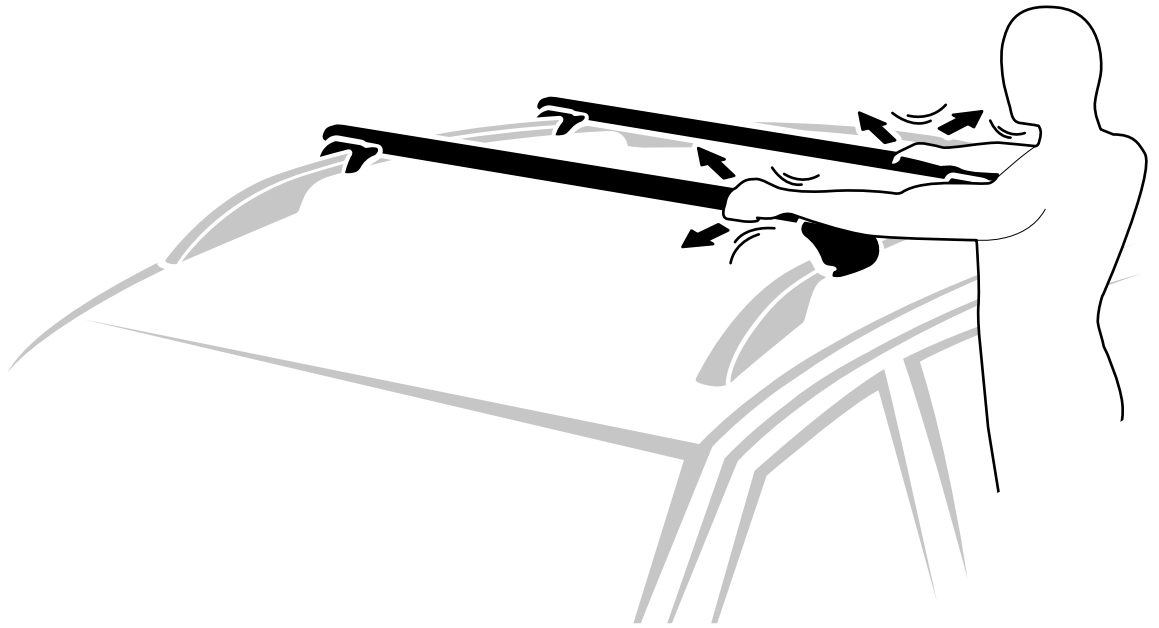

13

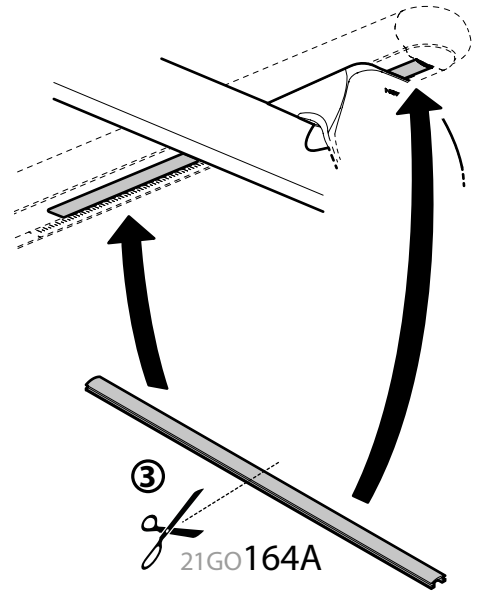
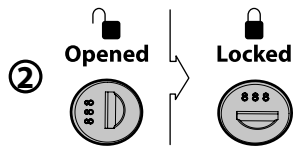
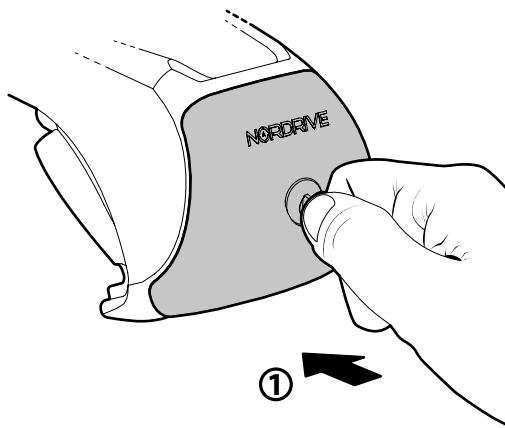
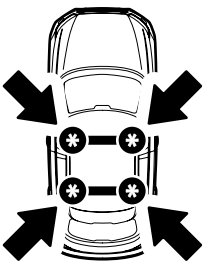



Attenzione • Warning • Attention • Hinweise • Advertencia

0100 Km

Pit-stop / Check!

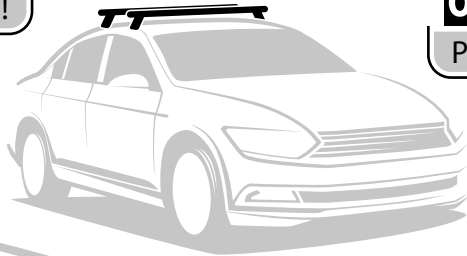

0250 Km

Pit-stop / Check!



0500 Km

Pit-stop / Check!



Pit-stop / Check!

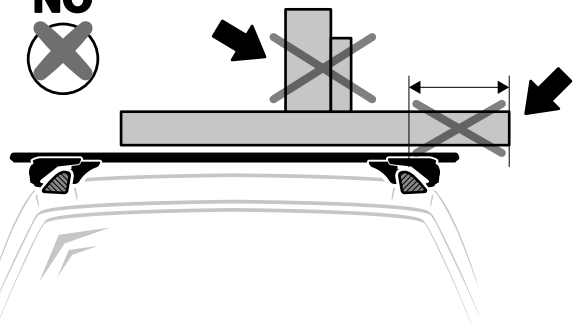
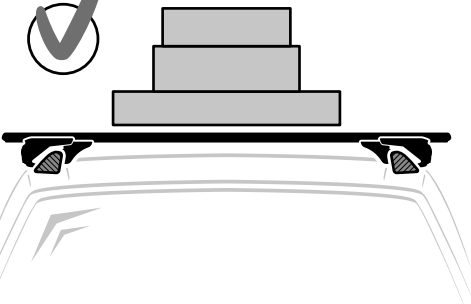
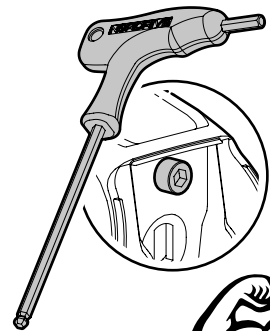
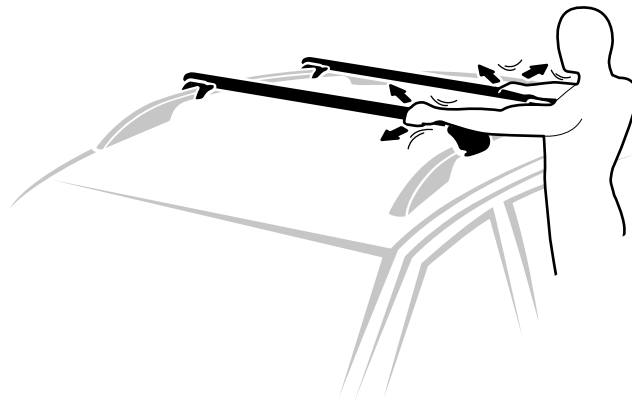

± 70cm

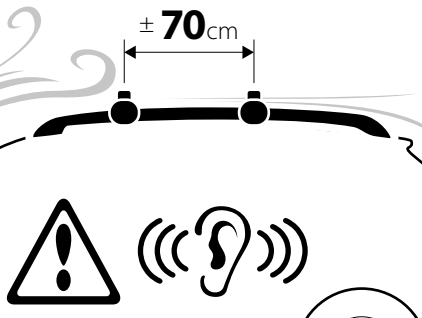

± 70cm

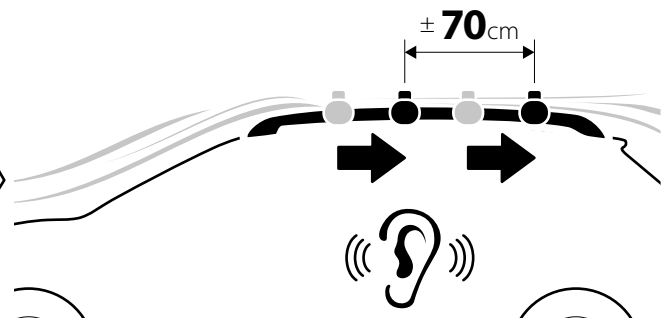



Attenzione • Warning • Attention • Hinweise • Advertencia

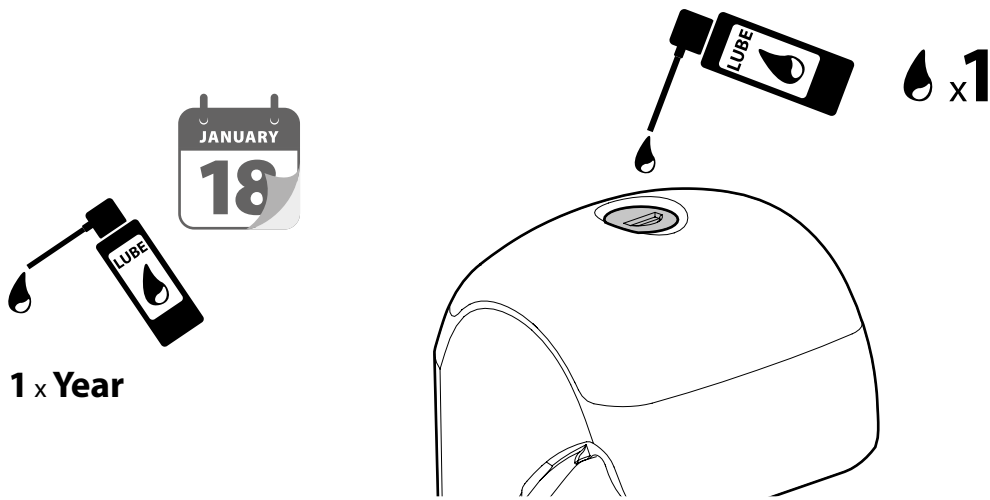
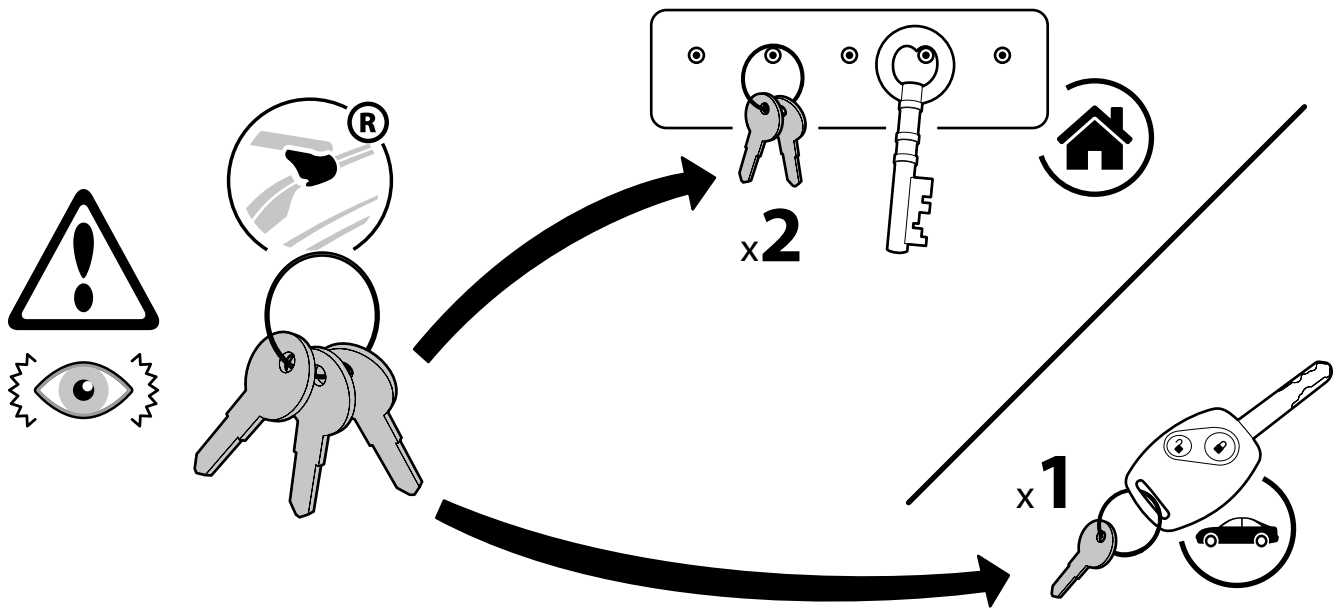

- ① Lotto di produzione da comunicare per eventuali ricambi
- Ⓒ Production lot number to be communicated for any spare parts
- Ⓕ Lot de production à communiquer pour toute pièce de rechange
- Ⓓ Produktionscharge für eventuelle Ersatzteile
- Ⓔ Lote de producción a comunicar por cualquier repuesto

Lot.

NORDRIVE®
TRANSPORT SOLUTIONS

**NORDRIVE® is a registered trademark of
LAMPA S.p.A.**

Via G. Rossa 53/55, 46019 Viadana (MN) ITALY

Tel. +39 0375 820700

UNI EN ISO 9001:2015 Certified Company

service@lampa.it

www.nordrive.it www.lampa.it